



**AG2H / AG2HP**  
**2 Burner Gas Boiling Hob**



British Built for Purpose.





# Welcome to Parry

Parry is one of the UK's foremost manufacturers of high-quality Stainless Steel Fabricated Products with a 40-year heritage rooted in British craftsmanship.

At Parry, quality and service are second nature. Striving to exceed our customers' expectations is not just our motto; it's the very heartbeat of our business. Our commitment to our customers is reflected in the **Parry 4E Standard Inspection Body** stating that all our products are:



**Easy to use**



**Easy to maintain**



**Easy to clean**



**Easy to repair**

Our ranges of Stainless Steel Products have been specifically designed with the consumer in mind and are tailored and compliant to your specific industry sector. All our products are 4E Compliant and meet EU & UK regulations, where applicable. The Parry brand stands for quality, reliability and value.

Our Catering designed products have been created by our expert in-house development team and manufactured to exacting standards using Industry specified grade of European stainless steel and holding relevant EU & UK certification for all product.

ISO9001 certification and continual investment in the training and development of our highly skilled, artisan workforce means that our clients have genuine peace of mind that they are buying hand crafted, quality products supported by five-star customer service. All Parry products meet EU regulations for their respective sector.

We are LEAN manufacturers, minimising waste, maximising productivity. We are proud to run a carbon neutral operation and are committed to minimising our impact on the environment.

Our equipment and furniture are manufactured in our 45,000 sq ft manufacturing facility in Draycott, Derbyshire in England's industrial heartland. Products are made to order if not available in our stocked items which means you can choose from 600 products, offering over 3,500 variants, with short lead times to suit your specific needs. That means you get exactly what you need when you need it.

Our product information can be found here, in our brochure or on our website [www.parry.co.uk](http://www.parry.co.uk).

You have my personal commitment that Parry will exceed your expectations. Should you have any questions please contact your distributor. Alternatively, our customer services team will be happy to help you on **01332 875544**.

**Mark Banton MBA**  
**Managing Director**



# Contents

---

Contents.....	1
Product Overview .....	2-3
Safety Instructions .....	4
Installation Instructions .....	5-6
Operating Instructions .....	7
Cleaning Instructions .....	7-8
Maintenance Instructions.....	8
Fault Finding.....	9
Replacement Parts.....	9
Natural Gas Conversion Instructions.....	10
LPG Conversion Instructions .....	11
Conversion Procedure .....	12-13
Technical Information .....	14
Service Information.....	15
Exploded View .....	16
Parts List .....	17
Warranty Information.....	18-19
Disposal & Recycling .....	20

Parry Catering Equipment (Midlands) Ltd, Town End Road, Draycott, Derby, DE72 3PT.  
Sales Tel: 01332 875544

Parry-British Built for Purpose



## Product Overview

---

### AG2H

The Parry natural gas two-burner hob is small yet powerful, making it the perfect appliance for smaller commercial catering establishments. The heavy duty enamelled pan supports are ideal for heavy pots and pans, while the high grade stainless steel is both durable and easy to clean.

### AG2HP

Ideal for smaller catering establishments, the Parry LPG gas two-burner hob is compact yet powerful. Constructed from durable stainless steel, the 300mm wide hob has heavy duty enamelled pan supports - perfect for the heavy pots and pans common in modern commercial kitchens.









## Product Overview

---

	AG2H	AG2HP
Unpacked weight (kg)	10	10
Packet weight (kg)	15	15
Dimensions (w x d x h) mm	300 x 695 x 220	300 x 695 x 220
Warranty	2 Years	2 Years
KW – Natural	11.1	n/a
KW – Propane/Butane	n/a	8.7
BTU – Natural	37,873	n/a
BTU – Propane/Butane	n/a	29,864
Input Gas Connection	¾" BSP Male	¾" BSP Male
GAS INPUT PRESSURE – Natural	20mbar	n/a
GAS INPUT PRESSURE – Propane	n/a	37mbar
GAS INPUT PRESSURE – Propane/Butane	n/a	n/a
Can be converted using conversion kit?	Yes	Yes

It leads the industry in:

-  Design and aesthetic appeal
-  Performance
-  Power
-  Functionality
-  After sales support



## Safety Instructions

---

### **IMPORTANT**

#### **PLEASE READ INSTRUCTIONS FULLY BEFORE USE** **INSTALLATION INSTRUCTIONS**

**THIS APPLIANCE IS ONLY FOR PROFESSIONAL USE AND MUST ONLY BE USED BY QUALIFIED PEOPLE.**

Attention should be drawn to the fact that parts of this unit by necessity, will get VERY HOT, and will cause burns if touched accidentally. Therefore, it is the responsibility of the supervisor or equivalent to provide SUITABLE PROTECTIVE CLOTHING for the user.

**THIS APPLIANCE MUST BE FITTED AND TESTED BY A REGISTERED FITTER BEFORE USE.**

The unit should be installed in compliance with the INSTALLATION INSTRUCTIONS and the NATIONAL REGULATIONS in force at the time. Particular attention should be paid to the Gas Safety (Installation and Use) Regulations and the Health and Safety at Work Act.

All commercial gas catering equipment is recommended to be mounted below an extraction canopy. Please consult a ventilation engineer or refer to Guidelines DW172 to calculate the ventilation requirements for cooking areas containing different pieces of gas catering equipment.

Each appliance requires a flow of fresh air for combustion. Under no circumstances should air vents on the appliances, or air vents installed by the fitter in the room of the appliance to supply combustion air, be altered or omitted in any way.

To prevent shocks, all appliances whether gas or electric, must be earthed.

**ANY GAS CONVERSIONS NEEDED TO BE MADE TO THE PRODUCT MUST BE CARRIED OUT BY A GAS SAFE REGISTERED ENGINEER**

To avoid scratching the highly polished exterior surface of this equipment whilst in transit, the protective film on the exterior surfaces has NOT been removed.

It is IMPORTANT that this protective film is peeled off before the equipment is used.



## Installation Instructions

---

**ALL APPLIANCES MUST BE FITTED AND OR CONVERTED BY A REGISTERED INSTALLER, IN ACCORDANCE WITH CURRENT REGULATIONS.**

Before installation check data plate on rear of unit to ensure appliance is suitable for gas supply available.

During installation provision must be provided for combustion air to the appliance through base and rear of appliance. This should not be blocked at any time. This appliance should be installed with sufficient ventilation to prevent the occurrence of unacceptable concentrations of substances harmful to health in the room in which it is installed.

### **POSITIONING**

The appliance must not be installed on or against combustible surfaces – minimum clearances must be:

**Rear 150mm (6")**

**Sides 150mm (6")**

**Hotplate to combustible material 1525mm (60")**

All local fire regulations should be observed.

It is recommended that the appliance be sited below a ventilating hood preferably of the extractor type incorporating a grease filter.



## Installation Instructions

---

### **GAS CONNECTION**

The size of the supply pipe should be no less than 3/4" B.S.P. and an easily accessible isolation tap fitted close to the appliance in the gas line. Although a rigid connection is recommended. An approved armoured flexible pipe may be used in conjunction with a straining cable.

Before the appliance is commissioned the gas, safety regulations require that all connections on the gas line are tested for gas soundness between the gas meter and the appliance.

All packing and protective film must be removed from panels etc. prior to commissioning the appliance.

All gas appliances must be fitted by a competent person to gas safety regulations in force.

Gas hoses used to connect the appliance to the gas supply must be of the correct specification for the gas and pressure of the appliance. The gas hose must comply with the national requirements in force, and be CE marked, of a metal braided construction suitable for commercial catering equipment. The hoses should be periodically examined and replaced as necessary

The tube or hose shall be fitted such that there are no sharp bends or torsional strain which may cause damage or failure of the tube or hose, especially near the end fittings. Torsional strain can be prevented using internal unions, swivel joints, etc. The bend radius should not exceed that stated by the Manufacturer. The hose should not touch the ground and should be no longer than 1.5m long.

A manual valve should be positioned upstream of the tube or hose unless the connection fitting incorporates a self-sealing quick release coupling.

Where a quick release coupling is used for horizontal travel such as in commercial catering appliances it is advisable that the coupling is facing downwards to prevent the ingress of debris and ensure the hose is formed into a smooth curve.

All units should have a restraining cable fitted preventing the unit from being pulled away from the wall and causing the gas hose to become disconnected accidentally.







## Operating Instructions

---

FOR FITTING INSTRUCTIONS SEE INSTALLATION SECTION.

### Operating the hob

All burners are fitted with flame failure devices.

1. To light hob unit turn knob to 
2. Press in and ignite gas with a match, keep knob held in for 15-20 seconds.
3. Release knob, gas should stay lit, if gas goes out repeat stage 2
4. The burner is now on full gas, to turn gas down, turn knob anti-clockwise, this is the  lowest setting, which is factory set.
5. To turn burners off, turn knob clockwise all the way round.

Parry recommends that the hob is used only with pans that have a minimum diameter of 120mm, and up to a maximum of 295mm diameter. This ensures that there is satisfactory combustion, and the pan is stable as it sits on the finger of the pan support.

We advise these appliances should not be left unattended while switched on.

These appliances are for professional use by qualified people only.



There are no user serviceable parts.

It is recommended that the sealed top plate is cleaned regularly to prevent build-up of fat and grease.



## Cleaning Instructions

---

-  It will be found that it takes less time and effort to clean the hob every time it has been used, particularly whilst still warm before grease and spillages are burnt on.
-  Proprietary cleaners must be used with care – they are highly corrosive and may cause damage to surfaces and components.
-  The stainless outer panels require a wipe down with warm soapy water.

**DO NOT USE SCOURING PADS.**



## Maintenance Instructions









---

**MAINTENANCE AND SERVICE MUST ONLY BE UNDERTAKEN BY REGISTERED FITTERS.**

**PLEASE NOTE THE LOW RATE ADJUSTER ON THE UNIT HAS BEEN FACTORY SET AND SHOULD NOT BE ADJUSTED UNLESS BY A QUALIFIED ENGINEER IN WHICH CASE THE LOW RATE ADJUSTER SHOULD BE RE-SEALED.**

Parry recommends that this unit is serviced at least every 6 months

As part of a full service we recommend the following checks are carried out.

-  Before any maintenance isolate the appliance from the gas supply
-  Examine and clean all burner and flame retention ports.
-  Using a combination of brushes, remove dust and lint from within the primary air ports venturi and burners. Check the burner aeration to ensure it is clear of debris.
-  Clean burner injectors ensuring orifices are not enlarged or damaged.
-  Stiff gas controls can in some instances be greased. Please ensure the correct type or grease is used.
-  Check any ignition electrodes and high tension leads where fitted. Clean and adjust where necessary
-  Check Door seal for damage and condition.
-  Reconnect gas supply and test all disturbed gas connections for gas tightness using a non-corrosive leak detection fluid.
-  Check the appliance burner operating pressure, heat input rating or where necessary both.



## Fault Finding

---

FAULT	POSSIBLE CAUSE	REMEDY
Incorrect flame picture, flame lift or noisy burner	Incorrect burner pressure, Blocked or partially blocked injector. Inadequate ventilation. Burner faulty/corroded/blocked	Check/adjust burner pressure Check /clean injector, Check ventilation. Check / clean burner and replace as necessary.
Burners will not stay alight	Faulty connection at thermocouple-valve, incorrectly located	Remake connection, reposition thermocouple
Burner goes out when turned to "low"	Blockage in tap	Clean and re-grease
Irregular flame	Burner ring/cap not correctly located, or low pressure	Relocate and check pressure at test point.



## Replacement Parts

---

### For Gas Safe Engineers only

**HOB TAP-** Remove pan supports, pull off control knobs and unclip fascia panel. Disconnect burner supply tube and thermocouple. Undo the 2 screws securing the tap to the rail. Check sealing washer and replace if necessary. Assemble in reverse order.

**HOB BURNER/THERMOCOUPLE** – Remove Pan Supports and Burner caps. Remove the solid top tray.  
Disconnect thermocouple from rear of tap. Undo locknut on burner mounting channel. Assemble in reverse order.



# Natural Gas Conversion Instructions

---

*Please note conversion kits sold separately*

**Product:** AG2HP – 2 Burner Gas Boiling Hob LPG

**These instructions can be used for converting from LPG to Natural Gas**

LPG units are designed and tested in accordance with all current regulations enforced to run on the following gases only

Nat Gas G20 @ 20mbar 8" W.G.

**PLEASE NOTE**

This conversion must be carried out by a Gas Safe Registered Engineer.

**This conversion kit includes**

	Description	Product Code	Quantity
<b>Hob valve bypass screw</b>	NAT GAS Hob valve bypass screw stamped with 85	COPBPS - 85	2
<b>Hob burner injector</b>	NAT GAS Hob Burner Injector stamped with 185	HOBINJECT185	2
<b>Labels</b>		NAT. GAS ONLY + G20	1
<b>Instructions</b>			CONVIN21-4



## LPG - Conversion Instructions

---

*Please note conversion kits sold separately*

**Product**            **AG2H – 2 Burner Gas Boiling Hob**

**These instructions can be used for converting from Natural Gas to LPG**

LPG units are designed and tested in accordance with all current regulations enforced to run on the following gases only

Propane G31 @ 37mbar 14.8" W.G.

**PLEASE NOTE**

This conversion must be carried out by a Gas Safe Registered Engineer.

**This conversion kit includes**

	<b>Description</b>	<b>Product Code</b>	<b>Quantity</b>
<b>Hob valve bypass screw</b>	LPG hob valve bypass screw stamped 50	COPBPS-50	2
<b>Hob burner injector</b>	LPG hob burner injector stamped 105	HOBINJECT105	2
<b>Labels</b>		G31 ONLY,	1
<b>Instructions</b>			CONVIN20-4



## Conversion Procedure

### Conversion Procedure for AG2H

#### Warning

Ensure the appliance is isolated from the gas supply before commencing conversion

Remove pan support and burner caps.

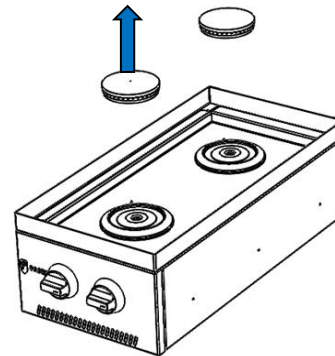
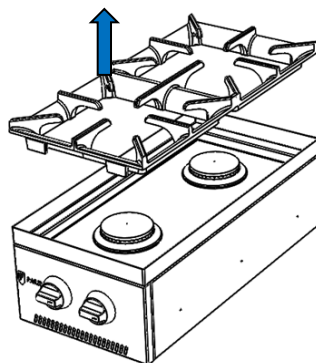

Lift off aluminium burner plates.

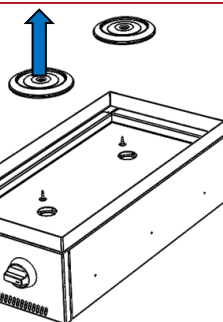

Remove the solid top plate.

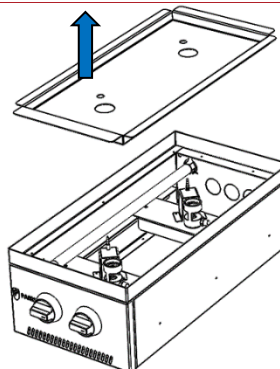

Using an 10mm spanner remove burner injector. Replace with injector from conversion kit. Replace solid top plate, aluminium burner plates and burner caps.

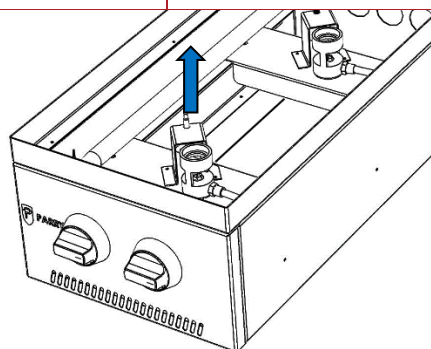

Remove the tap knobs to allow the fascia to unclip.

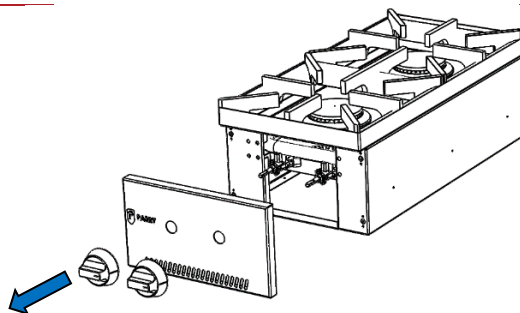



## Conversion Procedure

---

Remove low rate screws in tap body and replace with low rate screw from the conversion kit.

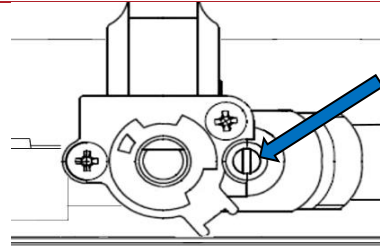

Connect the unit back to the gas supply  
Test for gas soundness

Replace the facia and knobs accordingly

When conversion is complete addix new data label and gas type label supplied with the conversion kit, detailing type of gas and pressure.



## Technical Information

### Per Hob Burner

GAS	OPERATING PRESSURE	TOTAL HEAT INPUT
NATURAL G20	20mb / 8" W.G.	5.557 KW = 18959 Btu/h
PROPANE G31	37mb / 14.8" W.G.	4.351 KW = 14846 Btu/h

GAS RATE	M <sup>3</sup> /HR	FT <sup>3</sup> /HR	LB/HR	KG/HR
NATURAL G20	0.588 M <sup>3</sup> /HR	20.765 FT <sup>3</sup> /HR		
PROPANE G31	0.178 M <sup>3</sup> /HR	6.286 FT <sup>3</sup> /HR	0.691 LB/HR	0.313 KG/HR
AIR FLOW RATE FOR COMBUSTION 20m <sup>3</sup> /HR		6.12 FT <sup>3</sup> /HR		

BURNER LOW RATE	FLOWRATE	HEAT INPUT
NATURAL G20	0.126 M <sup>3</sup> /HR	1.176 KW
PROPANE G31	0.029 M <sup>3</sup> /HR	0.700 KW

### Total Unit

GAS	OPERATING PRESSURE	TOTAL HEAT INPUT
NATURAL G20	20mb / 8" W.G.	11.113 KW = 37918 Btu/h
PROPANE G31	37mb / 14.8" W.G.	8.702 KW = 29692 Btu/h

GAS RATE	M <sup>3</sup> /HR	FT <sup>3</sup> /HR	LB/HR	KG/HR
NATURAL G20	1.176 M <sup>3</sup> /HR	41.530 FT <sup>3</sup> /HR		
PROPANE G31	0.356 M <sup>3</sup> /HR	12.572 FT <sup>3</sup> /HR	1.382 LB/HR	0.627 KG/HR
AIR FLOW RATE FOR COMBUSTION 20m <sup>3</sup> /HR		12.24FT <sup>3</sup> /HR		

BURNER LOW RATE	FLOWRATE	HEAT INPUT
NATURAL G20	0.253 M <sup>3</sup> /HR	2.357 KW
PROPANE G31	0.058 M <sup>3</sup> /HR	1.400 KW

### INJECTORS

Natural G20 = HOBINJECT 185

Propane G31 = HOBINJECT 105





## Service Information

---

This appliance should be routinely serviced to prolong its lifetime. Parry recommends that the appliance is serviced every 12 months by a Parry authorised engineer. Failure to service your product within the initial 12-month warranty period will cause the 24-month warranty to become void.

If the supply cord becomes damaged, it must be replaced by the manufacturer, it's service agent, or a similarly qualified person.

### Enhanced 2 Years Warranty

Parry Catering (Midlands) Ltd offer an enhanced warranty of two years (including parts and labour) on all of the Parry manufactured products. To take advantage of this you should register your warranty by logging onto the company website and filling out our simple form.

[www.parry.co.uk/the-parry-warranty](http://www.parry.co.uk/the-parry-warranty)

If you have any issues with your product and wish to request a warranty call you can contact our friendly team who will organize a Parry approved service engineer to attend and fix your problem.

All warranty requests can be sent to [warranty@parry.co.uk](mailto:warranty@parry.co.uk) alternatively call our warranty department for technical assistance on **01332 875544**





# Exploded View

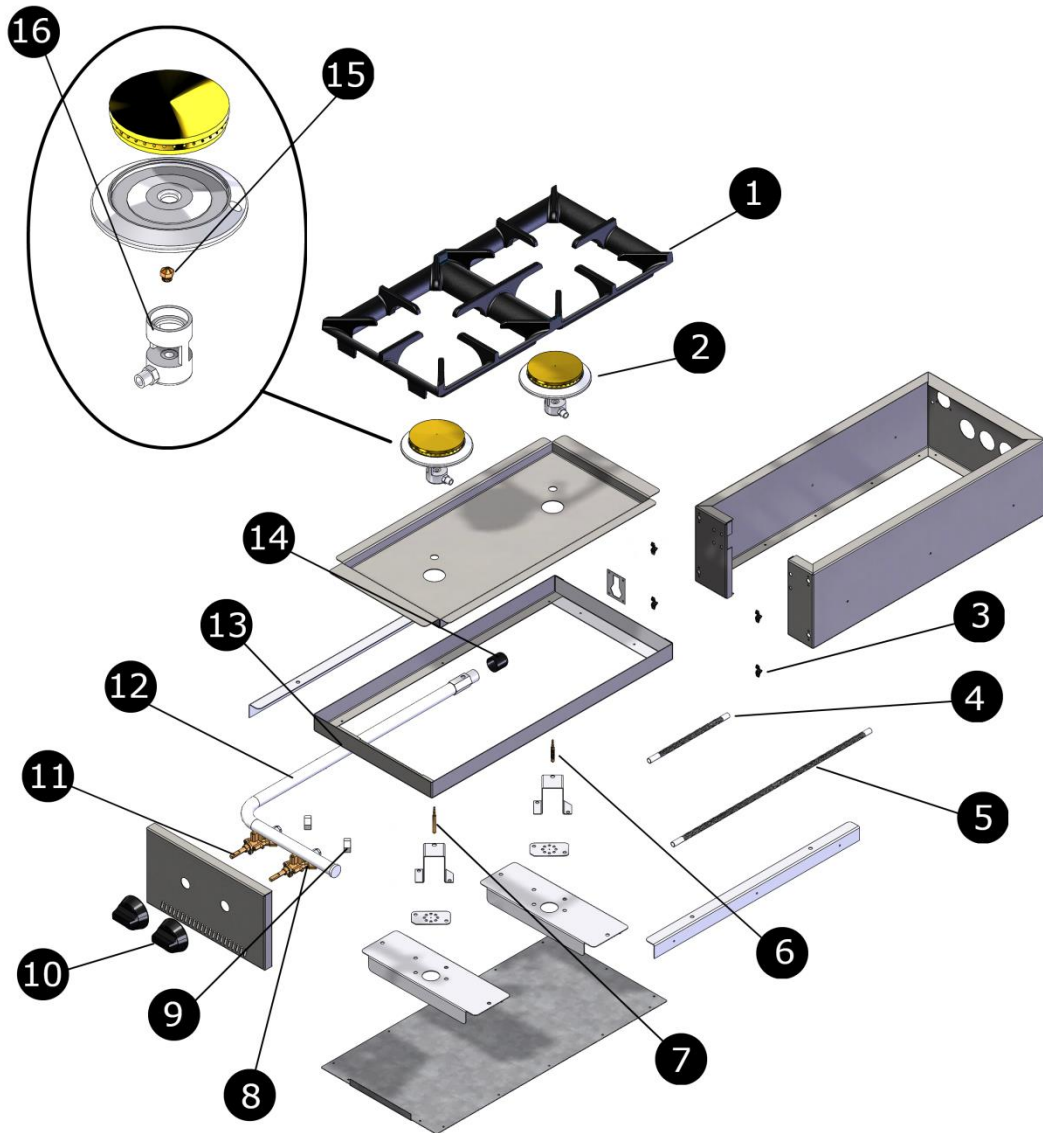



## Parts List

Part Number	Description	Code	Quantity
1	CAST PAN SUPPORT	CASTPANSUPP	2
2	HOB BURNER	BURNRHOB	7
3	SPRING CATCH USE WITH 40301384704 stud	CATCH0AWB	4
4	ST/ST FLEX TUBE 200MM X 8MM	FLEXT200X8	2
5	ST/ST FLEX TUBE 500MM X 8MM	FLEXT500X8	2
6	600MM Thermocouple & 2 x M8X1 Locknuts	THCP600ISP	2
7	320MM Thermocouple & 2 x M8X1 Locknuts	THCP320ISP	2
8 - Nat	NAT GAS 09920909 C BP	COPBPS-85	4
8 - LPG	CPB 09902187	COPBPS-50	4
9	COPRECI M14 x 1.5 NUT	COPM14NUT	4
10	GAS KNOB 5/16" DIA SHAFT	ULYKNOB2	4
11	HOB GAS TAP PARAGON RANGE	GASTAPHOB	4
12	GAS RAIL FOR AG4H / AG4HP	AG4HRAIL	1
13	Saddle 09707409	SADDLEBKT	10
14	Vinyl Round End Cap 26 mm ID 25mm Inside Height	PASCAP26MM	1
15 - Nat	Injector SP 8X100 185	HOBINJECT185	4
15 - LPG	Type SP 8x100 -105 Injector	HOBINJECT105	4
16	AEM Injector Carriage part of BURNRHOB	BURNRHOB	4



## Warranty Information

---

The manufacturer's warranty is only valid in the UK mainland. Northern Ireland, Western Isles, Inner Hebrides and Islands are parts only warranty. Please be aware that the warranty starts from the date of purchase from Parry and not the sale or installation date of the equipment.

To be eligible for a 2-year warranty, products must be serviced at least once within the first 12 months of purchase.

All service calls will be carried out between 8am and 5pm, Monday to Friday.

Your warranty is invalid if your equipment has not been installed in accordance with the manufacturer's instructions. The misuse, alteration or unauthorised repairs of the equipment will also invalidate the warranty.

During the warranty period it is at Parry's discretion whether to repair or replace the equipment.

The warranty only applies if the equipment has been used in a professional manner following the manufacturer's instructions and maintenance guidelines.

The warranty covers defects in the material and component failure only. We are not liable for trading loss, loss of perishable items, water damage or loss due to injury or fire damage.

Please ensure you have referred to the manufacturer's instruction before placing a warranty call.

Contact our warranty department on **01332 875544** for technical assistance.

Please have your model number ready before calling.

All warranty requests must be submitted to [warranty@parry.co.uk](mailto:warranty@parry.co.uk).

Failure to pay any warranty charges will result in your warranty being put on hold until the bill has been settled. Any issues regarding the raised charges should be put in writing to our warranty department for further investigation.













Register your product by visiting our website **[www.parry.co.uk](http://www.parry.co.uk)**



## Warranty Information

---

### Not covered under warranty

-  Fault due to incorrect installation, poor maintenance or equipment abuse.
-  Resetting of equipment or circuit breakers.
-  Faulty electrics – e.g. customer’s plug socket, plug, wiring, junction box fault, wrong fuse.
-  Products must be serviced within the first 12 months to be eligible for the 2-year warranty
-  Product not covered by warranty if combustible materials have been used, e.g. plastic trays.
-  Foil used on racks, blockages and lime scale issues.
-  Failure to grant access for pre-arranged service call.
-  Equipment that has been set up or used incorrectly e.g. dishwasher detergents, levelling and setting up of doors on a six-burner cooker
-  Excessive carbon build-up on griddle plates or overuse of lava rock on chargrills. (Recommended use by Parry no more than 2kg.)
-  Appliances that have been installed in mobile trailers are covered by parts only warranty for 24 months
-  Extraction canopies are sold with parts only warranty on the fans and speed controllers for 24 months. If parts are found to be faulty through lack of cleaning of the extraction canopy the part will be chargeable. The equipment should be installed by a competent person. The equipment installer needs to know the design, performance and the capacity of the ventilation system, so they can ensure adequate ventilation.
-  All the above points are not covered by warranty and any costs incurred, because of the above, will be forwarded to the parties responsible for placing the call.



## Disposal & Recycling

---

The packaging should be disposed of in accordance with the regulations in force.